

ANGULAR LIVE TOOL HOLDER

VDI 30 / DIN 5480

Product code:
NGT1-30/231-25/1.2-85

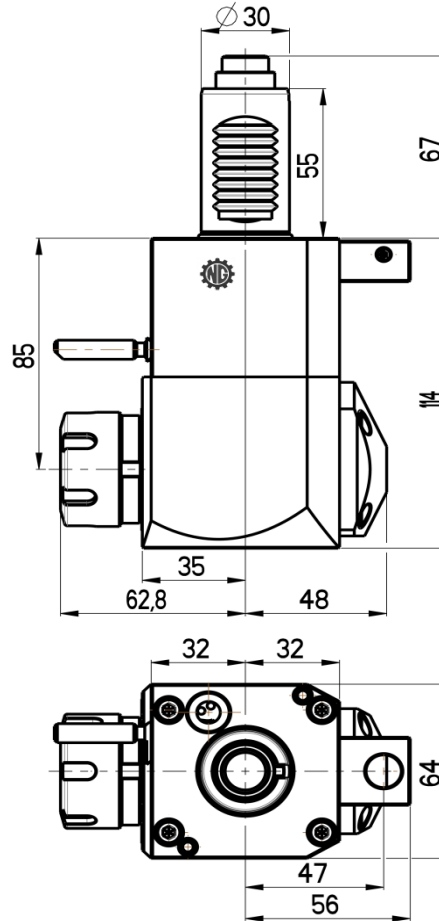
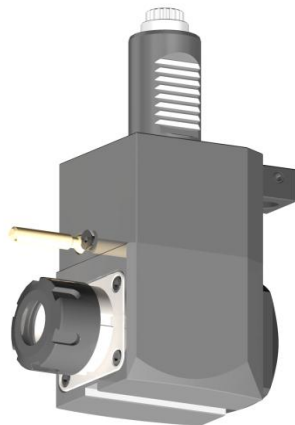

Max. speed: 6000 rpm

Max. torque: 28 Nm

Collet: ER25

Ratio: 1:1 (reverse direction)

Cooling: external (internal cooling available)

Accessories

Nut: Hook spanner type E 25

Spindle: Hook wrench DIN 1810A 40-42



www.microntooling.com

Subject to change without notice