

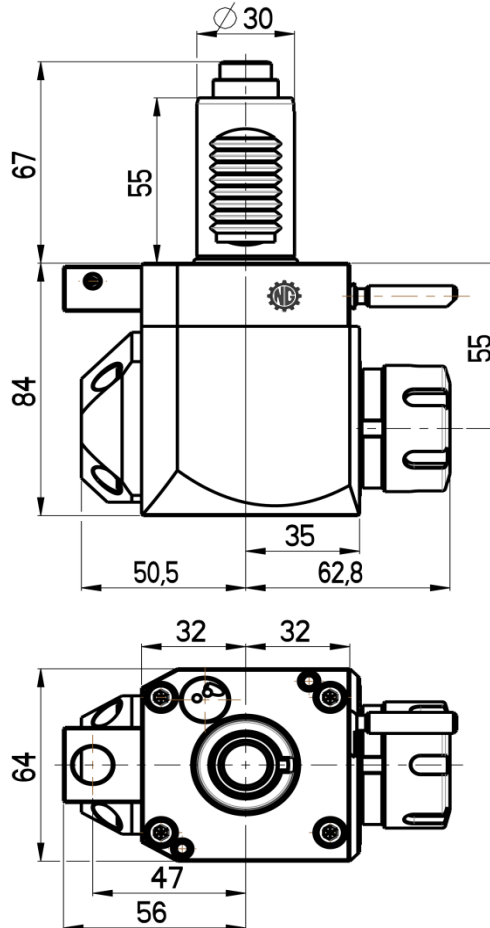

ANGULAR LIVE TOOL HOLDER

VDI 30 / DIN 5480

Product code:
NGT1-30/231-25/2.1-55

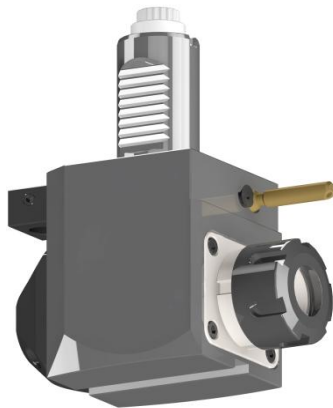

Max. speed: 6000 rpm

Max. torque: 28 Nm

Collet: ER25

Ratio: 1:1 (reverse direction)

Cooling: external & internal

Max. pressure: 20 bar

Accessories

Nut: Hook spanner type E 25

Spindle: Hook wrench DIN 1810A 40-42



www.microntooling.com

Subject to change without notice