

## ANGULAR LIVE TOOL HOLDER

VDI 30 / DIN 5480

Product code:  
NGT1-30/231-25/2.2-55

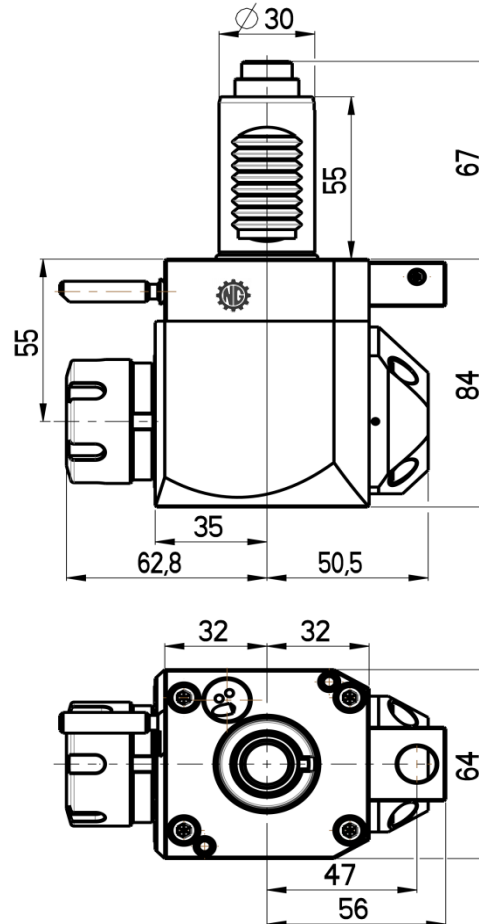
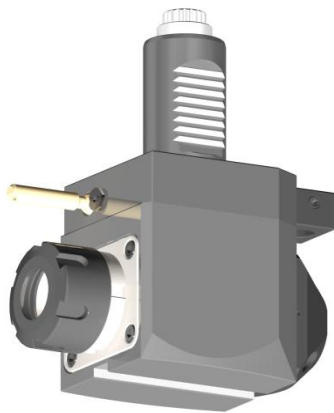

**Max. speed:** 6000 rpm

**Max. torque:** 28 Nm

**Collet:** ER25

**Ratio:** 1:1 (reverse direction)

**Cooling:** external & internal

**Max. pressure:** 20 bar

### Accessories

**Nut:** Hook spanner type E 25

**Spindle:** Hook wrench DIN 1810A 40-42



[www.microntooling.com](http://www.microntooling.com)

Subject to change without notice