

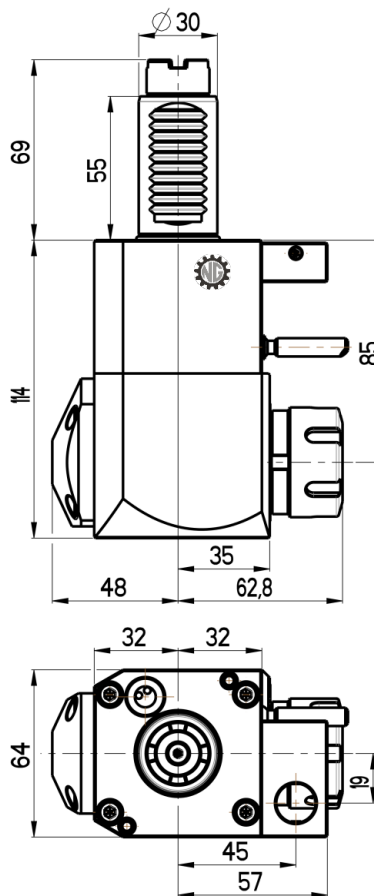

ANGULAR LIVE TOOL HOLDER

VDI 30 / STEPPED

Product code:
NGT1-30/251-25/1.1-85JA

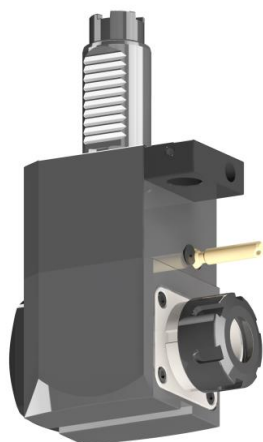

Max. speed: 6000 rpm

Max. torque: 28 Nm

Collet: ER25

Direction of rotation: 

Ratio: 1:1

Cooling: external (internal cooling available)

Accessories

Nut: Hook spanner type E 25

Spindle: Hook wrench DIN 1810A 40-42

