

STRAIGHT LIVE TOOL HOLDER

VDI 40 / DIN 5482

Product code:
NGT1-40/111-25/2

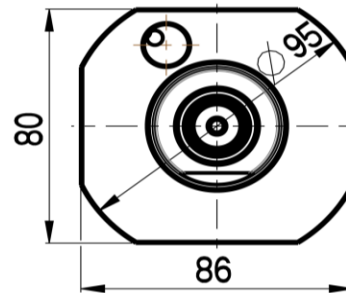
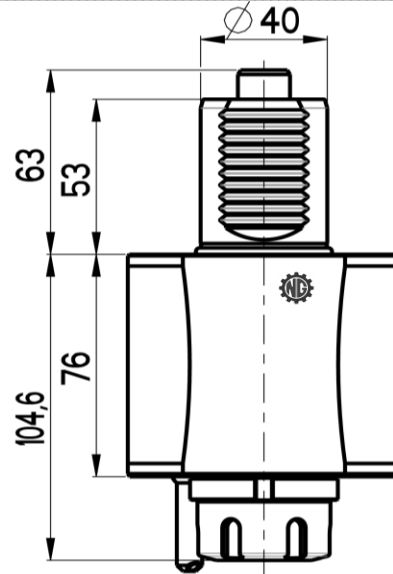

Max. speed: 6000 rpm

Max. torque: 50 Nm

Collet: ER25

Ratio: 1:1

Cooling: external & internal

Max. pressure: 20 bar

Accessories

Nut : Hook spanner type E 25

Spindle: Hook wrench DIN 1810A 45-50



www.microntooling.com

Subject to change without notice