

ANGULAR LIVE TOOL HOLDER

VDI 40 / DIN 1809

Product code:
NGT1-40/221-25/1.2-100D

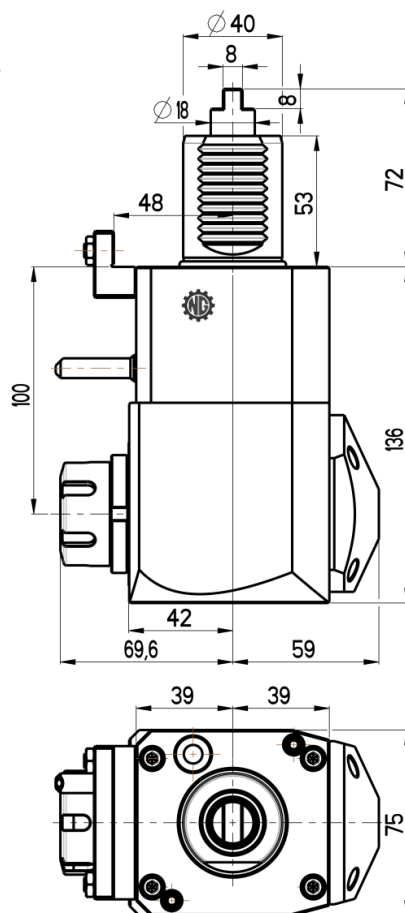
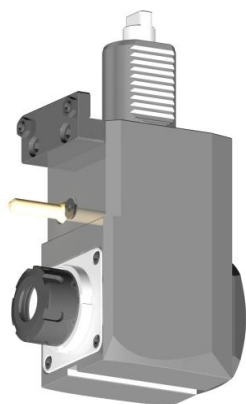

Max. speed: 6000 rpm

Max. torque: 50 Nm

Collet: ER25

Ratio: 1:1 (reverse direction)

Cooling: external (internal cooling available)

Accessories

Nut : Hook spanner type E 25



Spindle: Hook wrench DIN 1810A 45-50

www.microntooling.com

Subject to change without notice