

ANGULAR LIVE TOOL HOLDER

VDI 40 / DIN 1809

Product code:
NGT1-40/221-32/2.2-100D

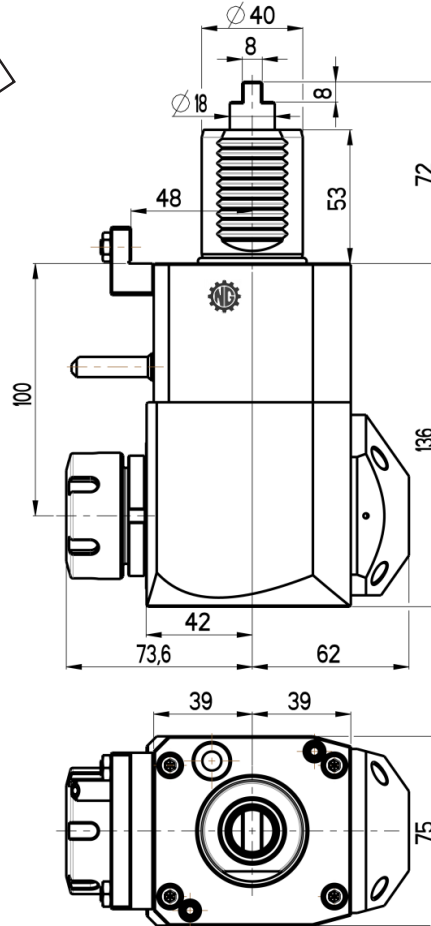
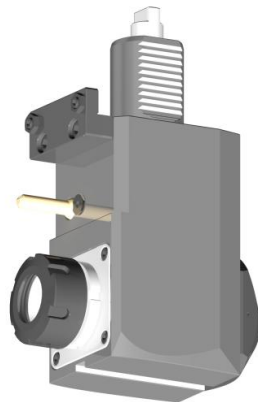

Max. speed: 6000 rpm

Max. torque: 50 Nm

Collet: ER32

Ratio: 1:1 (reverse direction)

Cooling: external & internal

Max. pressure: 20 bar

Accessories

Nut : Hook spanner type E 32

Spindle: Hook wrench DIN 1810A 45-50

