

ANGULAR LIVE TOOL HOLDER

VDI 40 / DIN 5480

Product code:
NGT1-40/231-32/2.1-80

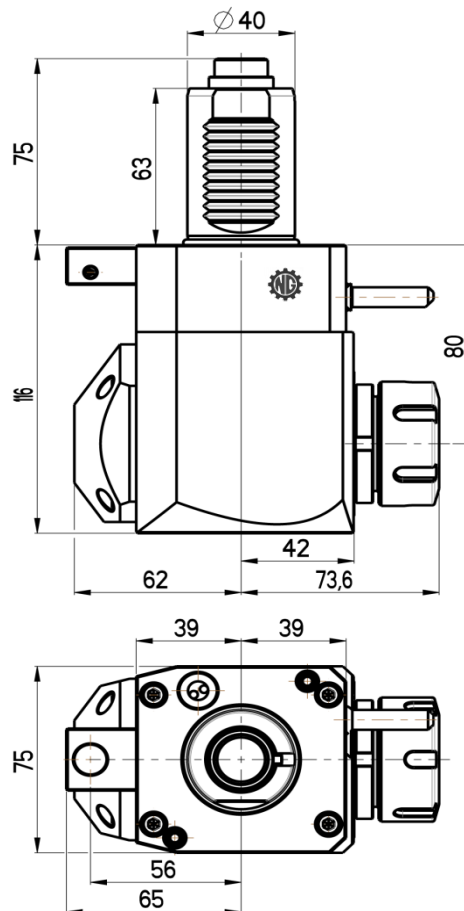
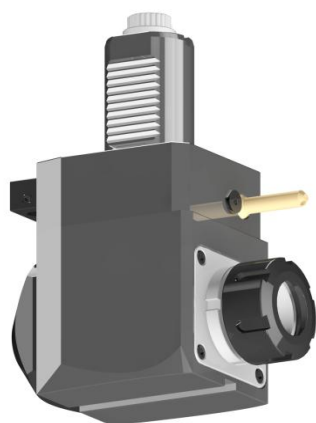

Max. speed: 6000 rpm

Max. torque: 50 Nm

Collet: ER32

Ratio: 1:1 (reverse direction)

Cooling: external & internal

Max. pressure: 20 bar

Accessories

Nut: Hook spanner type E 32

Spindle: Hook wrench DIN 1810A 45-50



www.microntooling.com

Subject to change without notice