

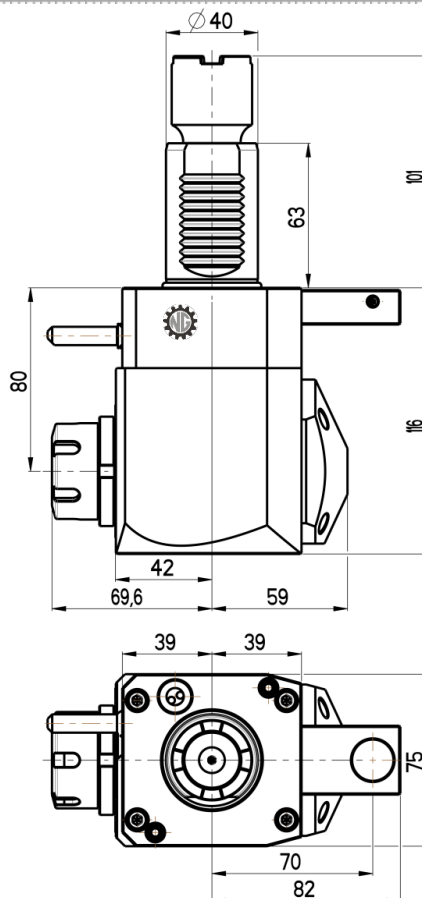

## ANGULAR LIVE TOOL HOLDER

### VDI 40 / STEPPED

Product code:  
**NGT1-40/251-25/1.2-80JB**

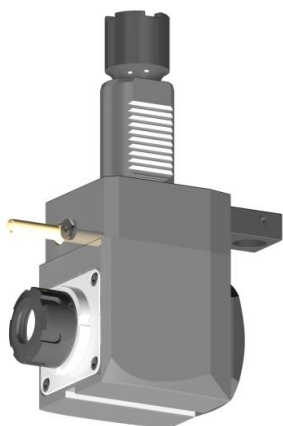

**Max. speed:** 6000 rpm

**Max. torque:** 50 Nm

**Collet:** ER25

**Direction of rotation:** 

**Ratio:** 1:1

**Cooling:** external (internal cooling available)

#### Accessories

**Nut:** Hook spanner type E 25

**Spindle:** Hook wrench DIN 1810A 45-50

