

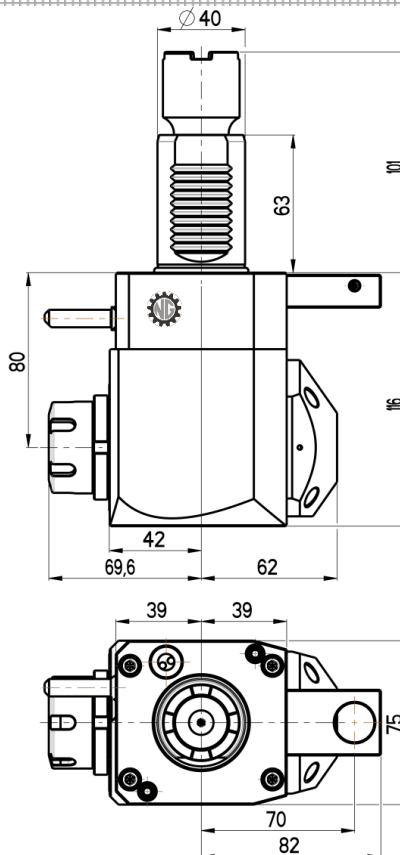

ANGULAR LIVE TOOL HOLDER

VDI 40 / STEPPED

Product code:
NGT1-40/251-25/2.2-80JB

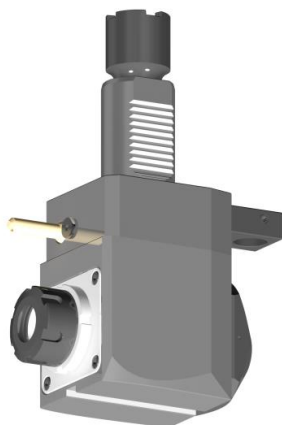

Max. speed: 6000 rpm

Max. torque: 50 Nm

Collet: ER25

Direction of rotation: 

Ratio: 1:1

Cooling: external & internal

Max. pressure: 20 bar

Accessories

Nut : Hook spanner type E 25



Spindle: Hook wrench DIN 1810A 45-50

