

ANGULAR LIVE TOOL HOLDER

VDI 40 / STEPPED

Product code:
NGT1-40/251-32/1.2-80C

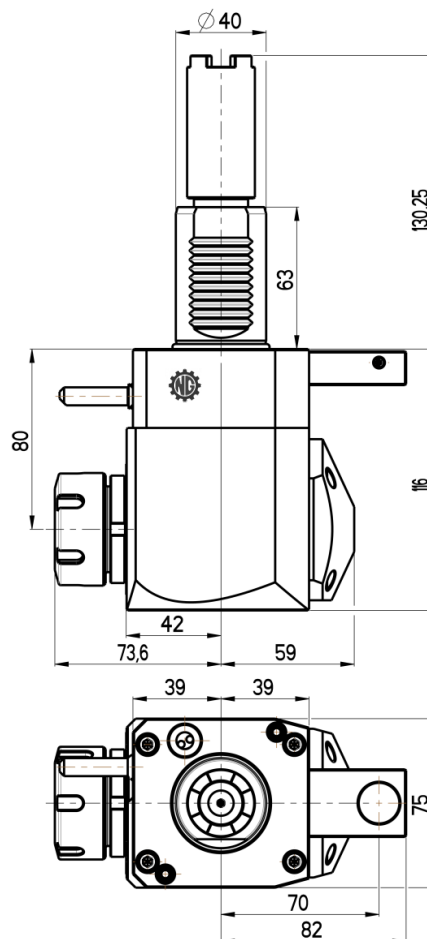
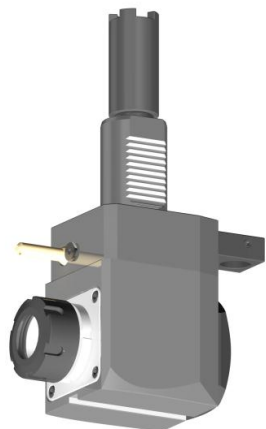

Max. speed: 6000 rpm

Max. torque: 50 Nm

Collet: ER32

Ratio: 1:1 (reverse direction)

Cooling: external (internal cooling available)

Accessories

Nut: Hook spanner type E 32

Spindle: Hook wrench DIN 1810A 45-50

