

## OFFSET ANGULAR LIVE TOOL HOLDER

VDI 40 / DIN 5482

Product code:  
**NGT1-40/411-25/2.1-120**

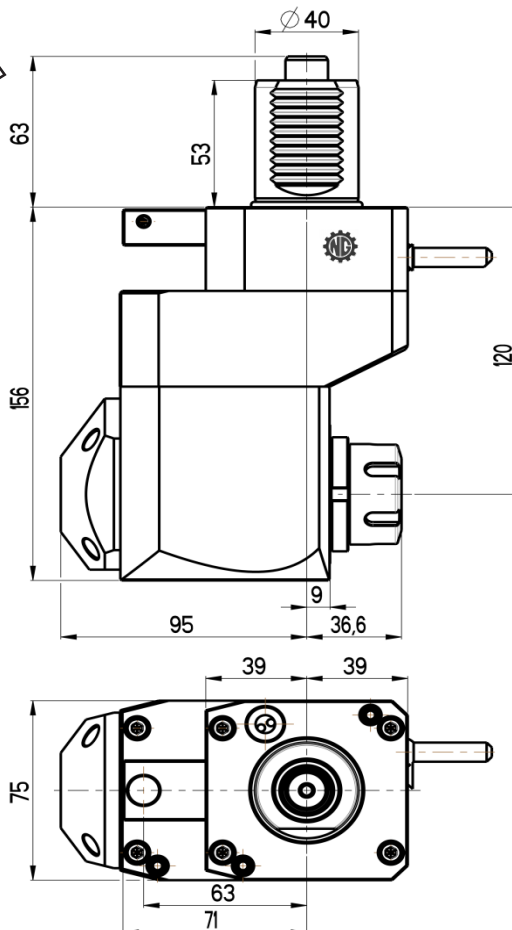
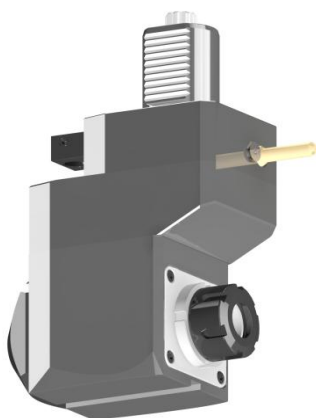

**Max. speed:** 6000 rpm

**Max. torque:** 50 Nm

**Collet:** ER25

**Ratio:** 1:1

**Cooling:** external & internal

**Max. pressure:** 20 bar

### Accessories

**Nut:** Hook spanner type E 25

**Spindle:** Hook wrench DIN 1810A 45-50



[www.microntooling.com](http://www.microntooling.com)

Subject to change without notice