

**OFFSET ANGULAR
LIVE TOOL HOLDER**

VDI 40 / TOEM 200

Product code:
NGT1-40/441-32/1.1-120

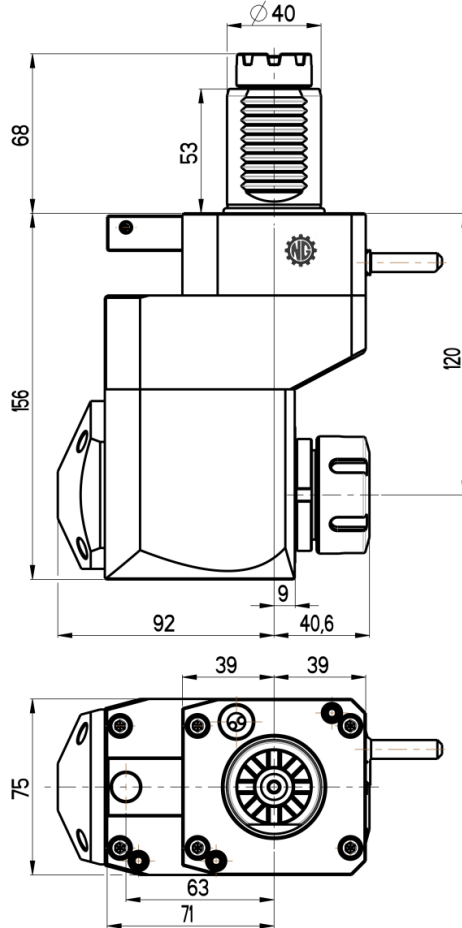
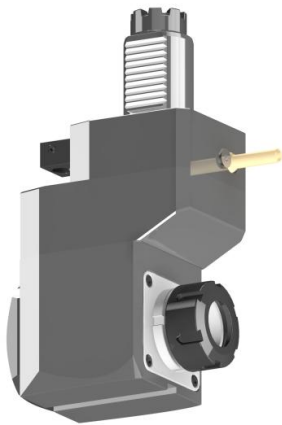

Max. speed: 6000 rpm

Max. torque: 50 Nm

Collet: ER32

Ratio: 1:1

Cooling: external (internal cooling available)

Accessories

Nut : Hook spanner type E 32

Spindle: Hook wrench DIN 1810A 45-50

